

CHAPTER 5G

TRADITIONAL

Product Information

Unit Features 5G.2
Profile Options 5G.3
Panel Elevations / Details 5G.4

Panel elevations in the following chapter are conceptual and are drawn for general information only. Please contact your Marvin Entry Door representative for options.

NOTE:

Specifications and technical data are subject to change without notice.
Allow 1/16" (2) tolerance on all measurements.
Metric measurements are shown in parenthesis.
For accessories dimensions and applications see the Accessories section of this manual.
For technical assistance about Marvin Entry Door products you may call 1-877-627-6385
or visit our website: www.marvin.com.

PANEL COLLECTIONS – TRADITIONAL



UNIT FEATURES

Traditional Collection:

With simple straight forward lines and attractive raised moulding and raised designs, these doors add the warmth of wood to an entry system.

Raised Mouldings:

- The standard mouldings on these doors are our M23 Profile.

Panels:

- The P400 raised panel is used in this door.

Accessories:

- Wood accessories can be added to this door. Please see wood accessories section.

Note:

Values shown in parenthesis represent metric equivalents.

For product specifications please refer to the CSI Product Specifications CD, or contact your Marvin Entry Door representative.

PANEL COLLECTIONS – TRADITIONAL



Profile Options

Profile Options - Traditional								
Door #	Moulding	Panel	System "A"	System "B"	System "C"	System "D"	System "E"	Minimum Width*
1020	M23	P400	X	X	X	X	X	18 1/2" (470)
1021	M23	P400	X	X	X	X	X	18 1/2" (470)
1022	M23	P400	X	X	X	X	X	18 1/2" (470)
1023	M23	P400	X	X	X	X	X	18 1/2" (470)
1024AT	M23	P400	X		X			18 1/2" (470)
1025	M23	P400	X	X	X	X	X	18 1/2" (470)
1030	M23	P400	X	X	X	X	X	18 1/2" (470)
1040	M23	P400	X	X	X	X	X	28 63/64" (736)
1045	M23	P400	X	X	X	X	X	28 63/64" (736)
1050	M23	P400	X	X	X	X	X	28 63/64" (736)
1060	M23	P400	X	X	X	X	X	28 63/64" (736)
1065	M23	P400	X	X	X	X	X	28 63/64" (736)
1080	M23	P400	X	X	X	X	X	28 63/64" (736)
1082	M23	P400	X	X	X	X	X	28 63/64" (736)

NOTE:

Please contact your Marvin Entry Door Technical Support representative for additional size. Minimums and maximums will vary with different styles.

PANEL COLLECTIONS – TRADITIONAL

TRADITIONAL DOOR 1020 (PROFILE M23/P400 SHOWN)

SCALE: 3/4" = 1' 0"

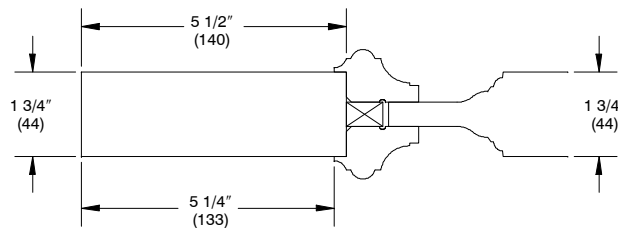
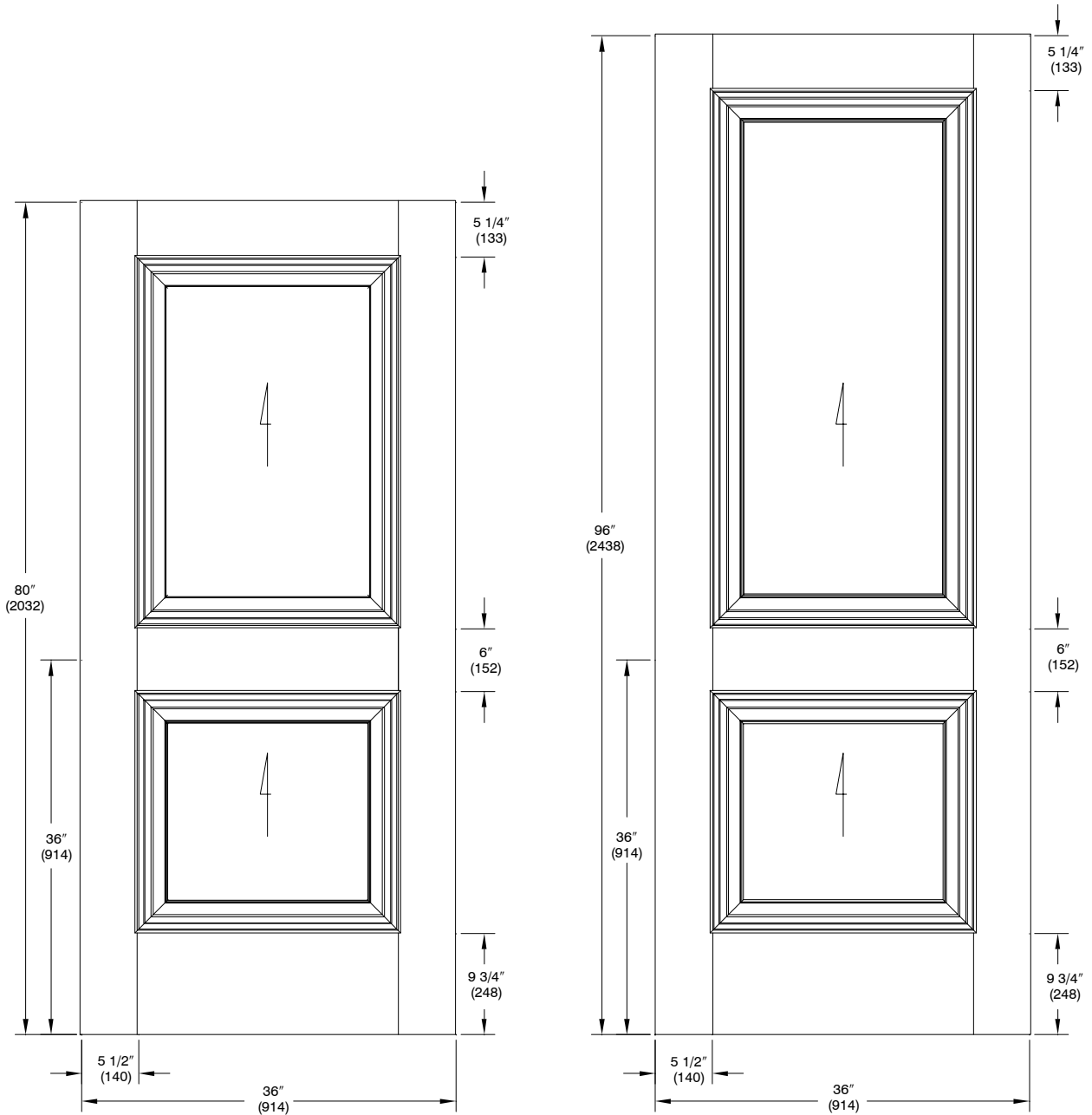

Profile M23/P400 shown

NOTE:
Panel sizes will be adjusted for operating clearance.

PANEL COLLECTIONS – TRADITIONAL

TRADITIONAL DOOR 1021 (PROFILE M23/P400 SHOWN)

SCALE: 3/4" = 1' 0"

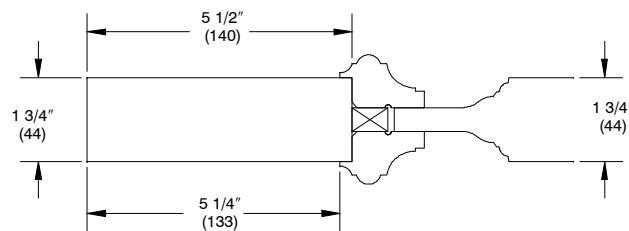
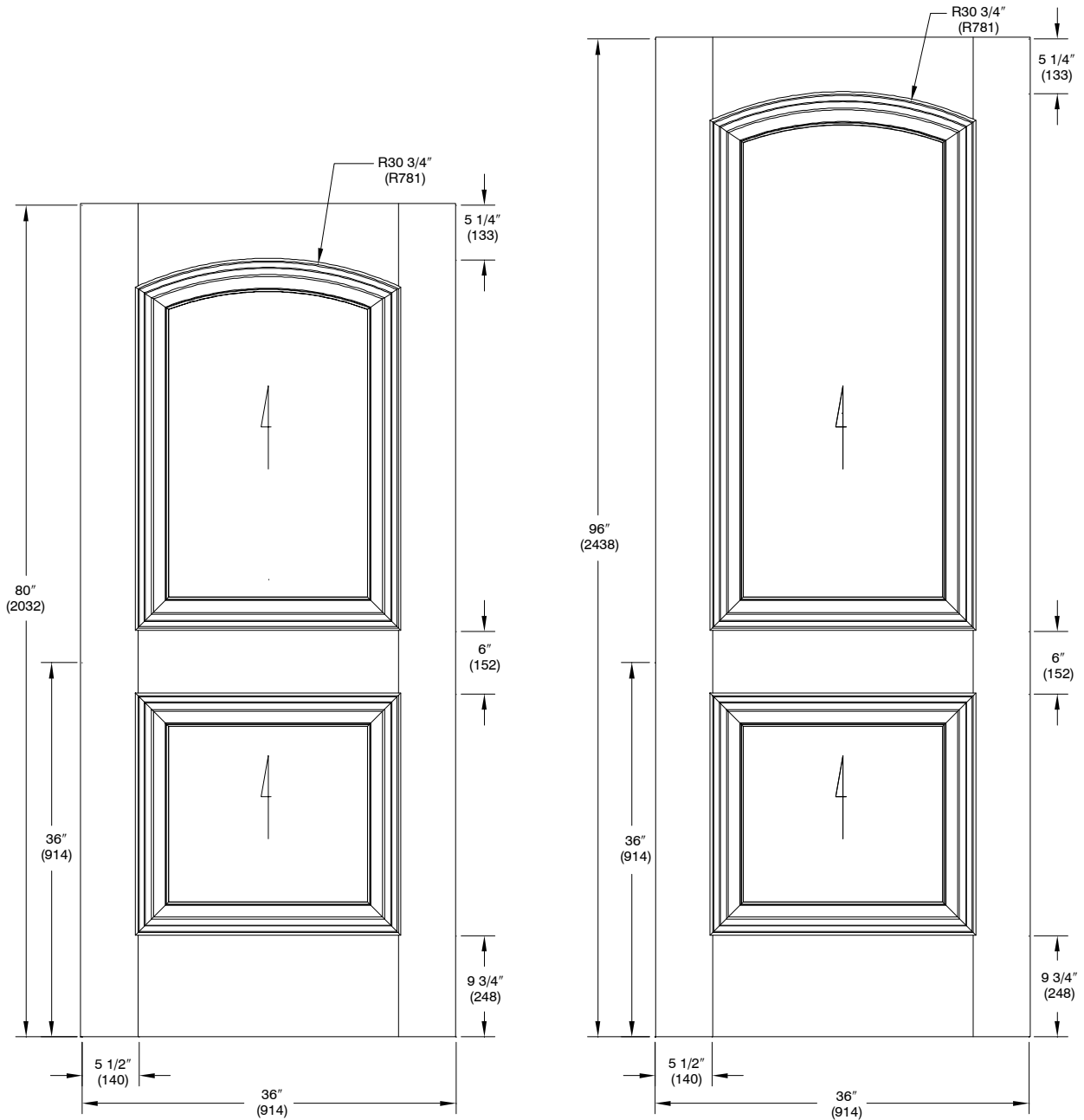

Profile M23/P400 shown

NOTE:
Panel sizes will be adjusted for operating clearance.

PANEL COLLECTIONS – TRADITIONAL

TRADITIONAL DOOR 1022 (PROFILE M23/P400 SHOWN)

SCALE: 3/4" = 1' 0"

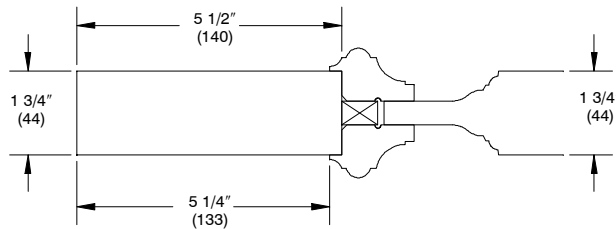
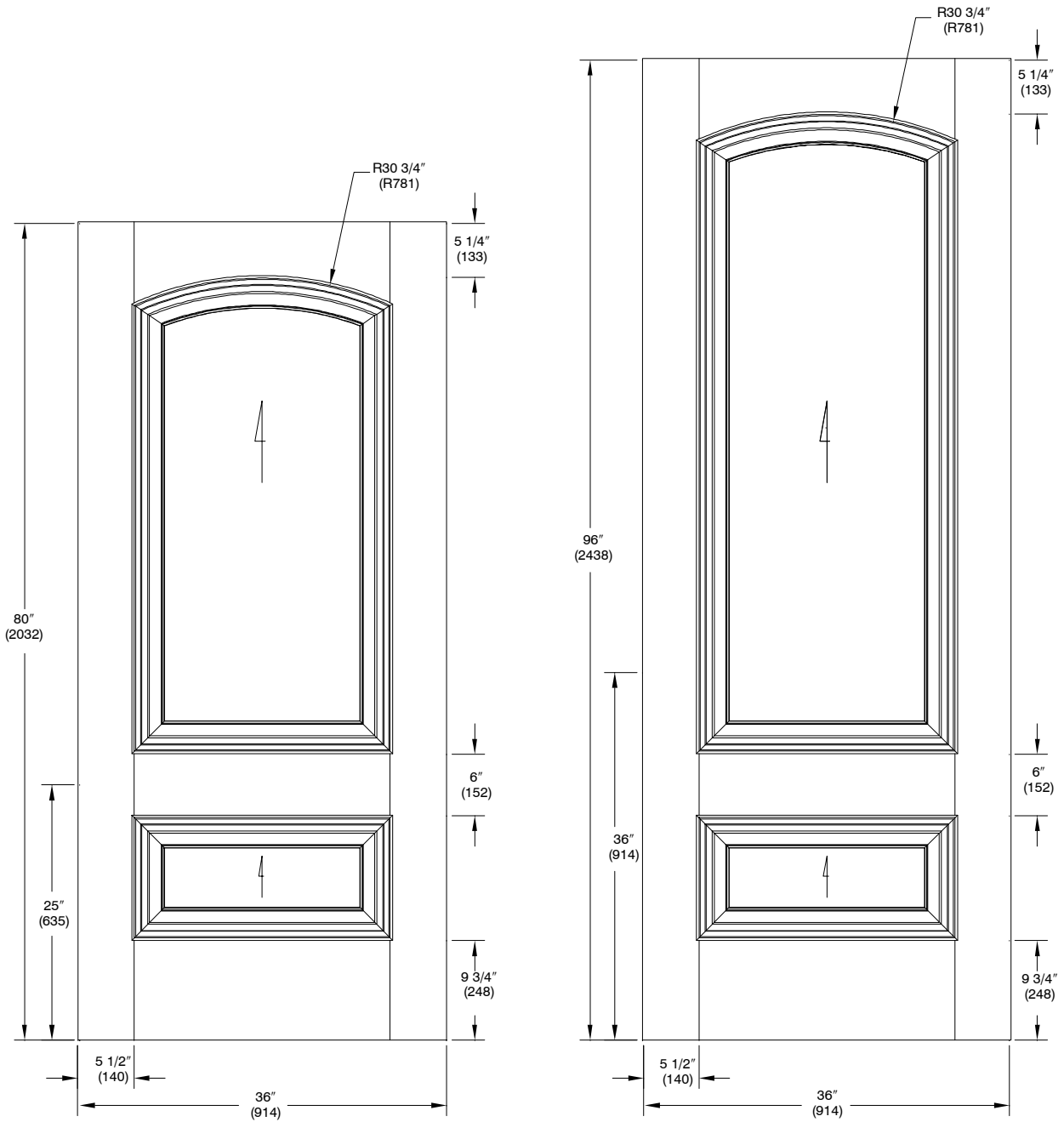

Profile M23/P400 shown

NOTE:
Panel sizes will be adjusted for operating clearance.

PANEL COLLECTIONS – TRADITIONAL

TRADITIONAL DOOR 1023 (PROFILE M23/P400 SHOWN)

SCALE: 3/4" = 1' 0"

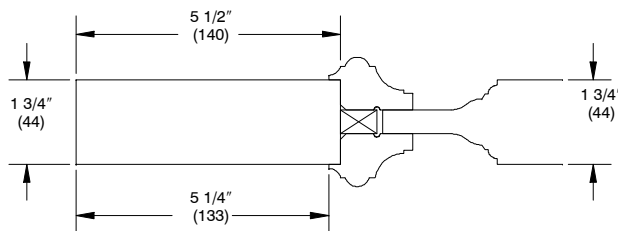
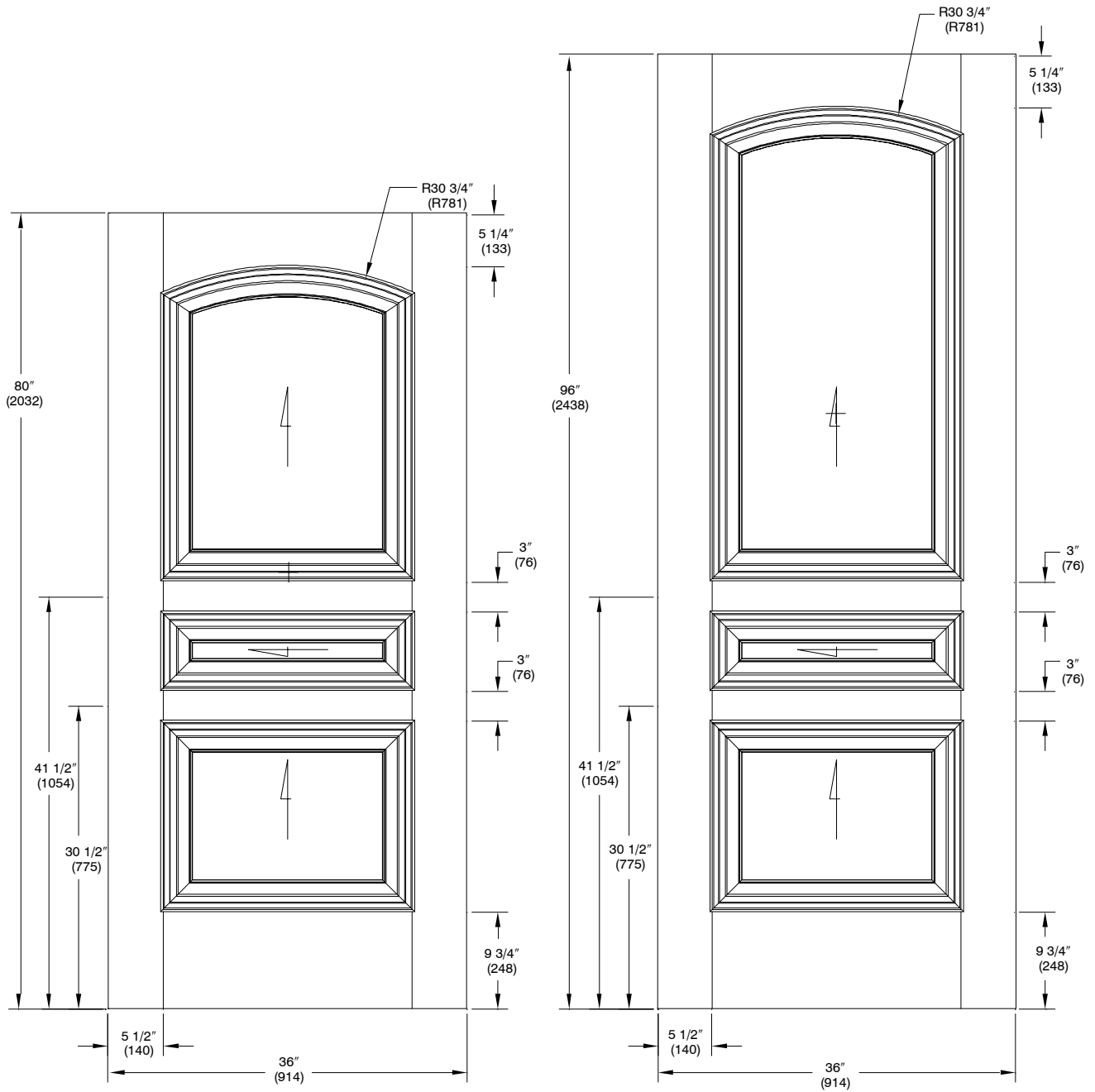

Profile M23/P400 shown

NOTE:
Panel sizes will be adjusted for operating clearance.

PANEL COLLECTIONS – TRADITIONAL

TRADITIONAL DOOR 1025 (PROFILE M23/P400 SHOWN)

SCALE: 3/4" = 1' 0"

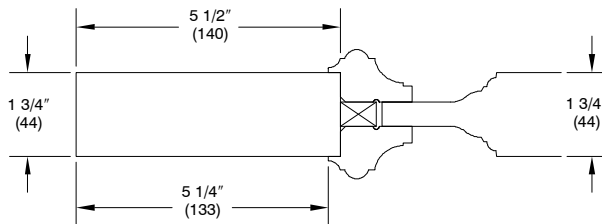
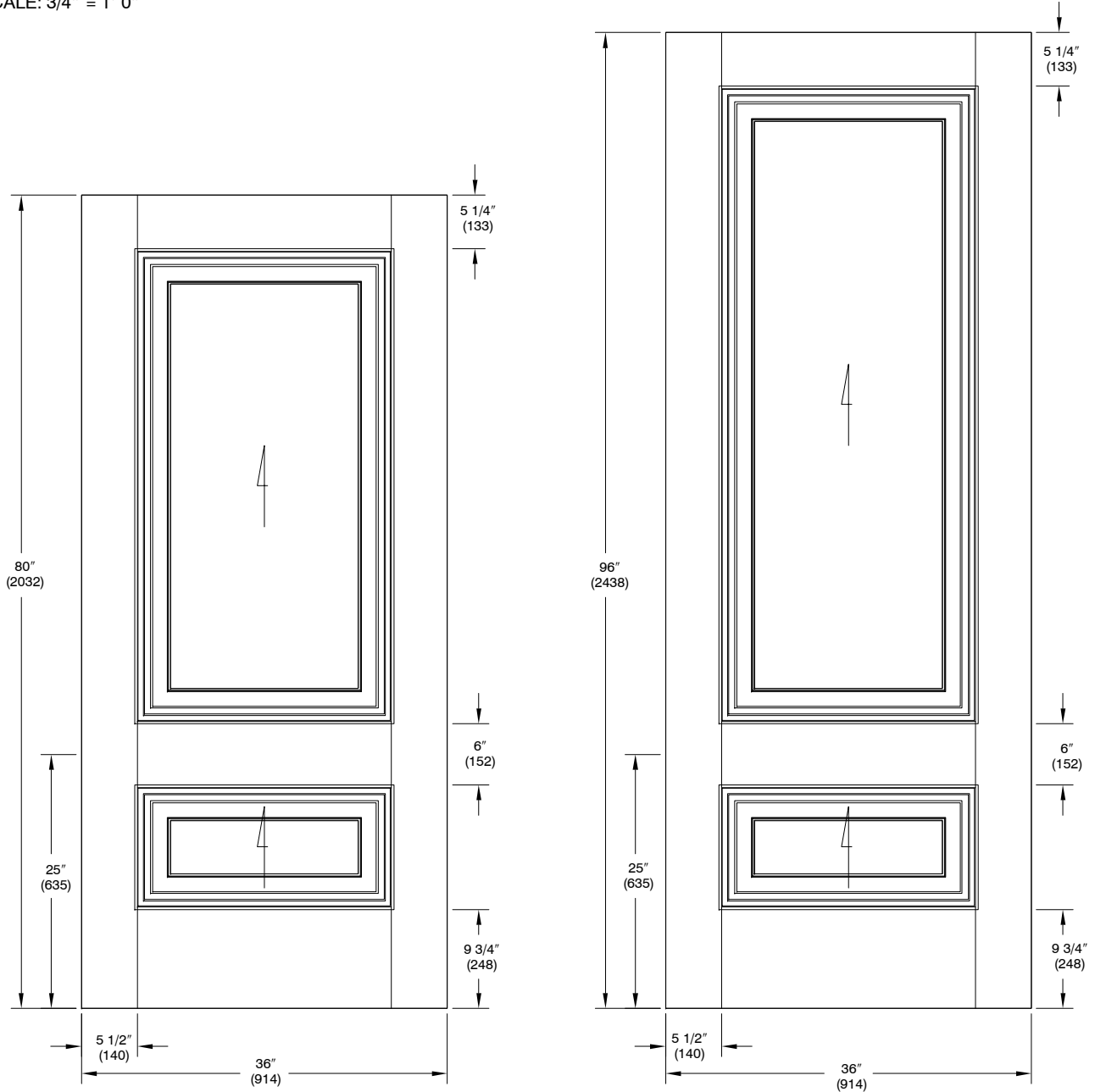

Profile M23/P400 shown

NOTE:
Panel sizes will be adjusted for operating clearance.

PANEL COLLECTIONS – TRADITIONAL

TRADITIONAL DOOR 1030 (PROFILE M23/P400 SHOWN)

SCALE: 3/4" = 1' 0"

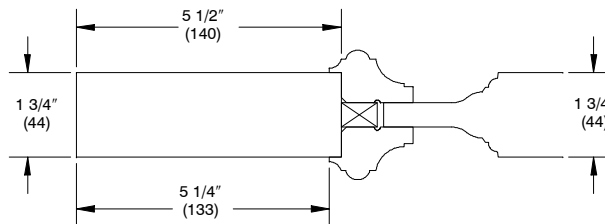
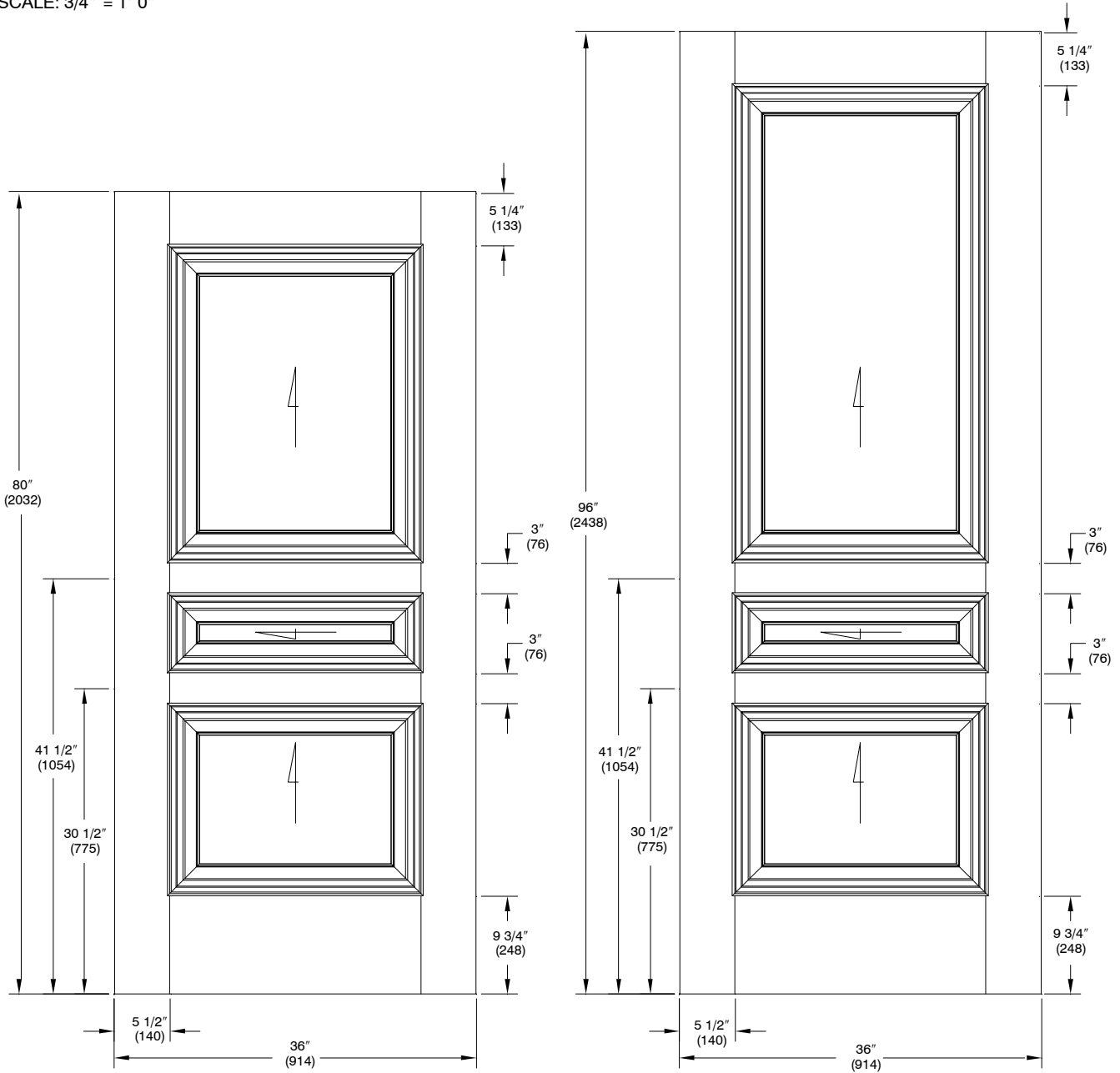

Profile M23/P400 shown

NOTE:

Panel sizes will be adjusted for operating clearance.

PANEL COLLECTIONS – TRADITIONAL

TRADITIONAL DOOR 1040 (PROFILE M23/P400 SHOWN)

SCALE: 3/4" = 1' 0"

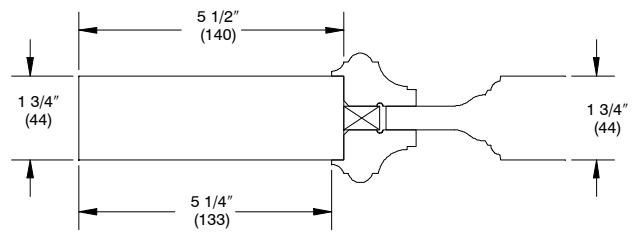
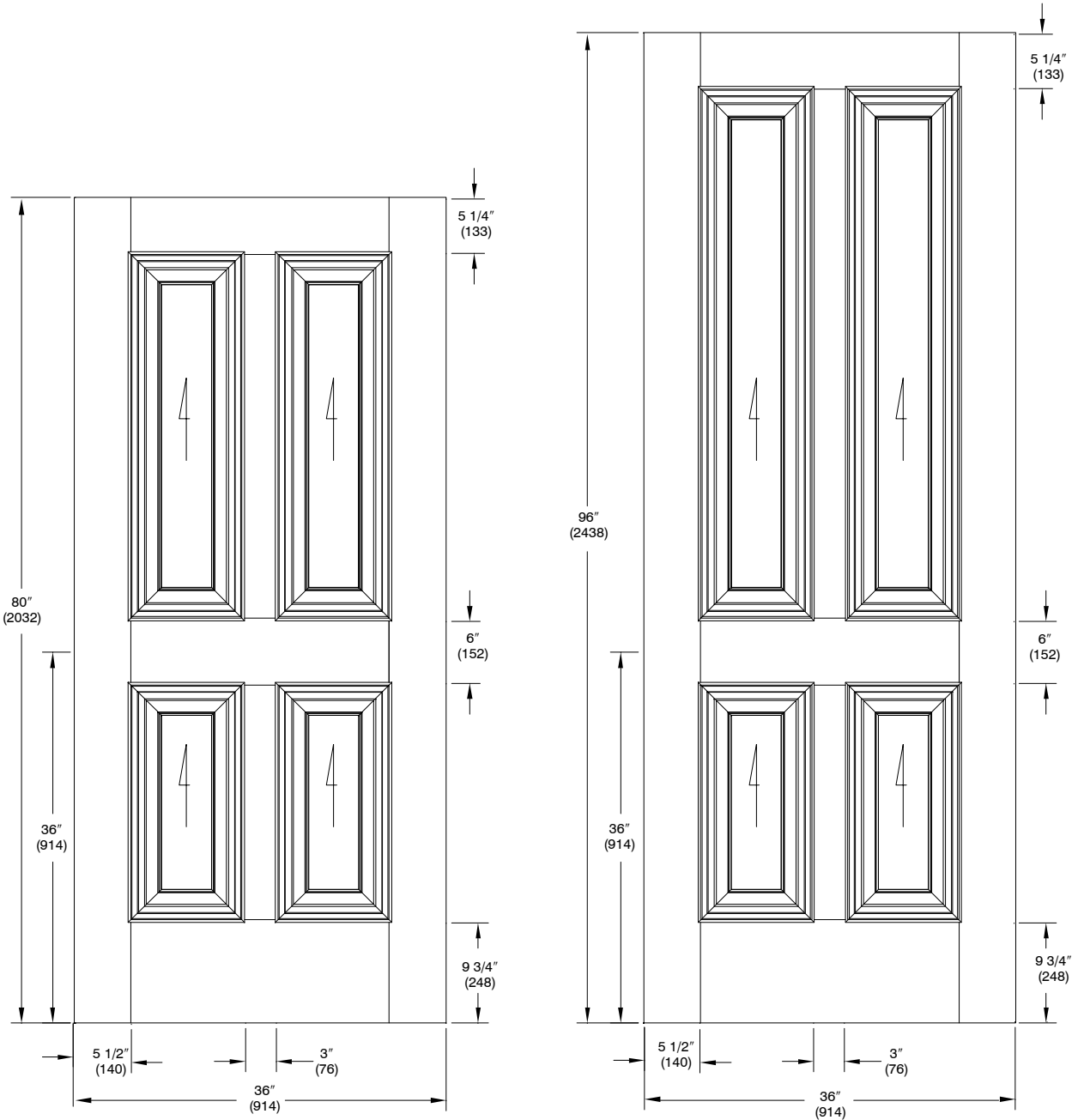

Profile M23/P400 shown

NOTE:
Panel sizes will be adjusted for operating clearance.

PANEL COLLECTIONS – TRADITIONAL

TRADITIONAL DOOR 1045 (PROFILE M23/P400 SHOWN)

SCALE: 3/4" = 1' 0"

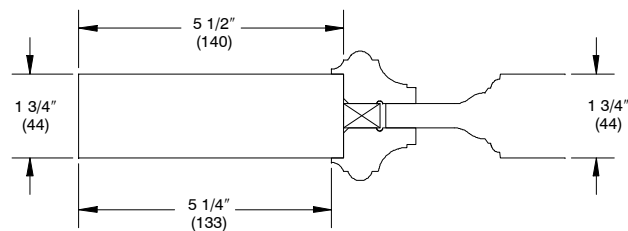
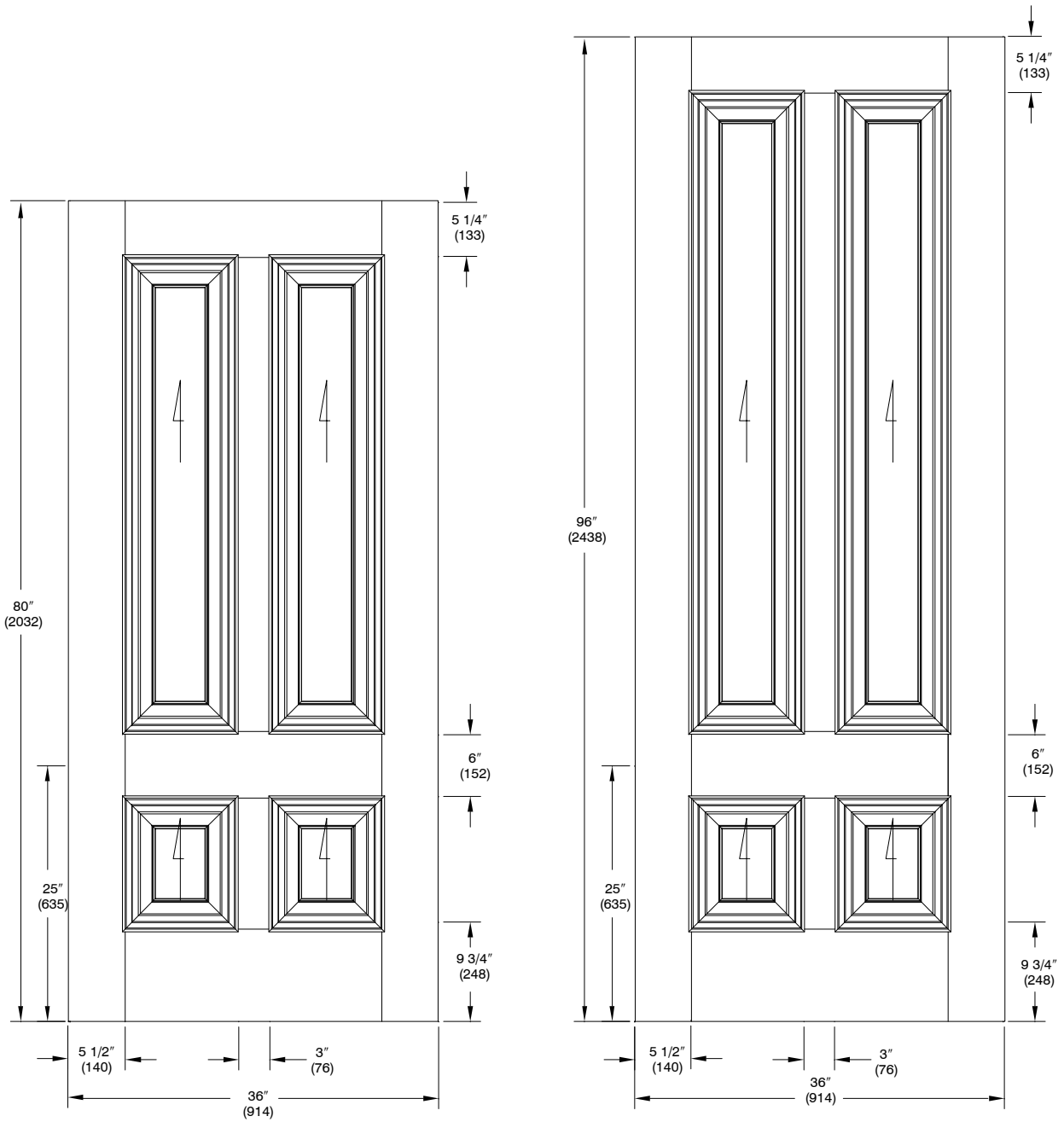

Profile M23/P400 shown

NOTE:
Panel sizes will be adjusted for operating clearance.

PANEL COLLECTIONS – TRADITIONAL

TRADITIONAL DOOR 1050 (PROFILE M23/P400 SHOWN)

SCALE: 3/4" = 1' 0"

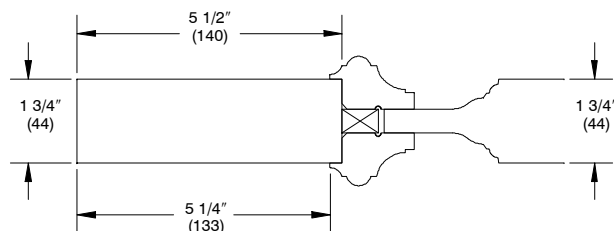
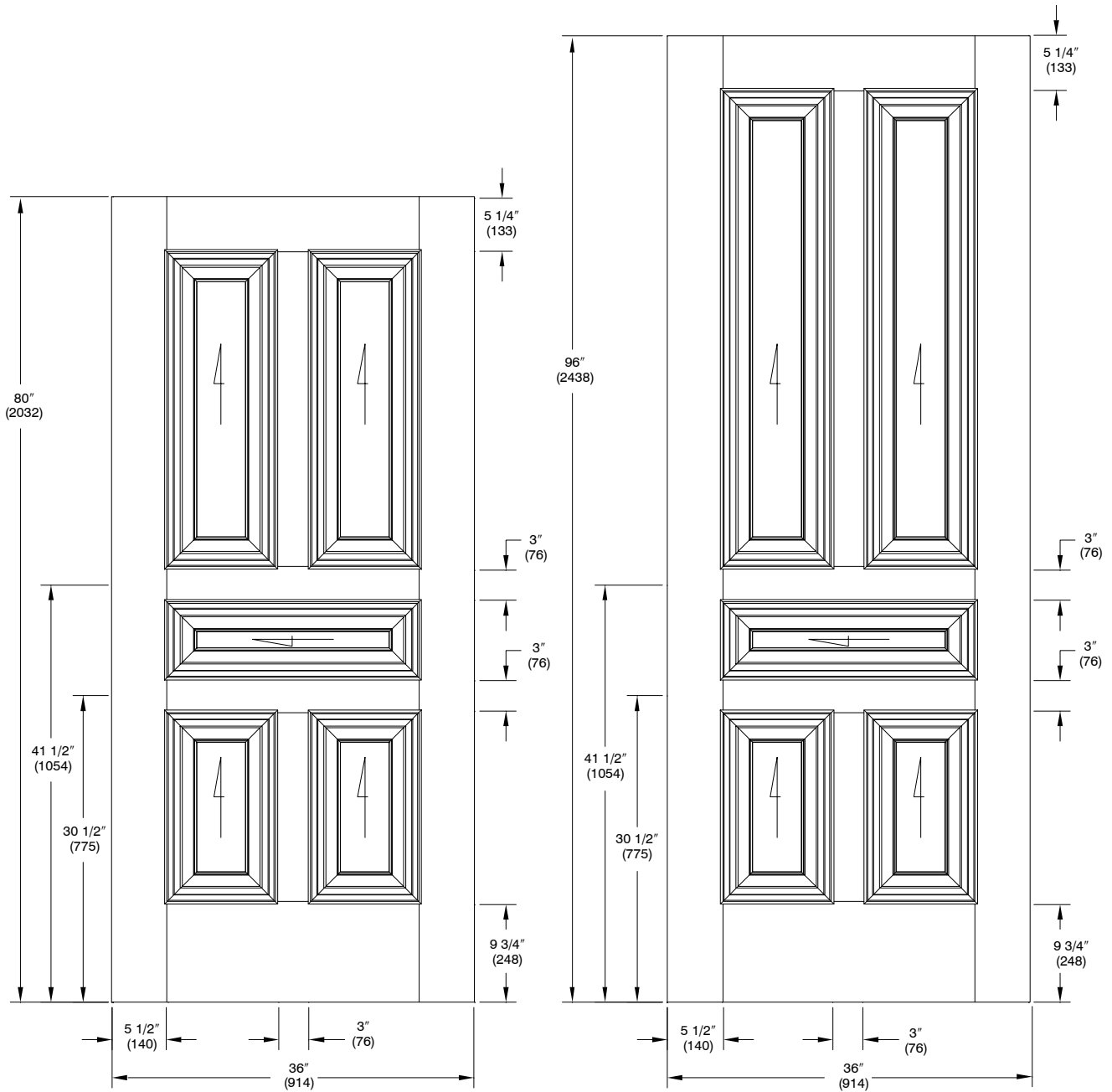

Profile M23/P400 shown

NOTE:
Panel sizes will be adjusted for operating clearance.

PANEL COLLECTIONS – TRADITIONAL

TRADITIONAL DOOR 1060 (PROFILE M23/P400 SHOWN)

SCALE: 3/4" = 1' 0"

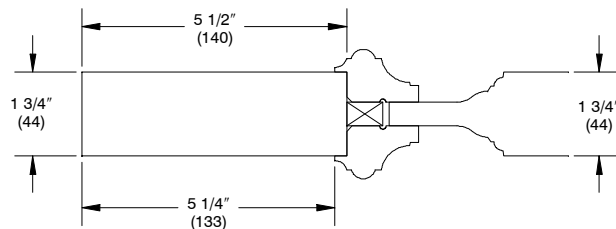
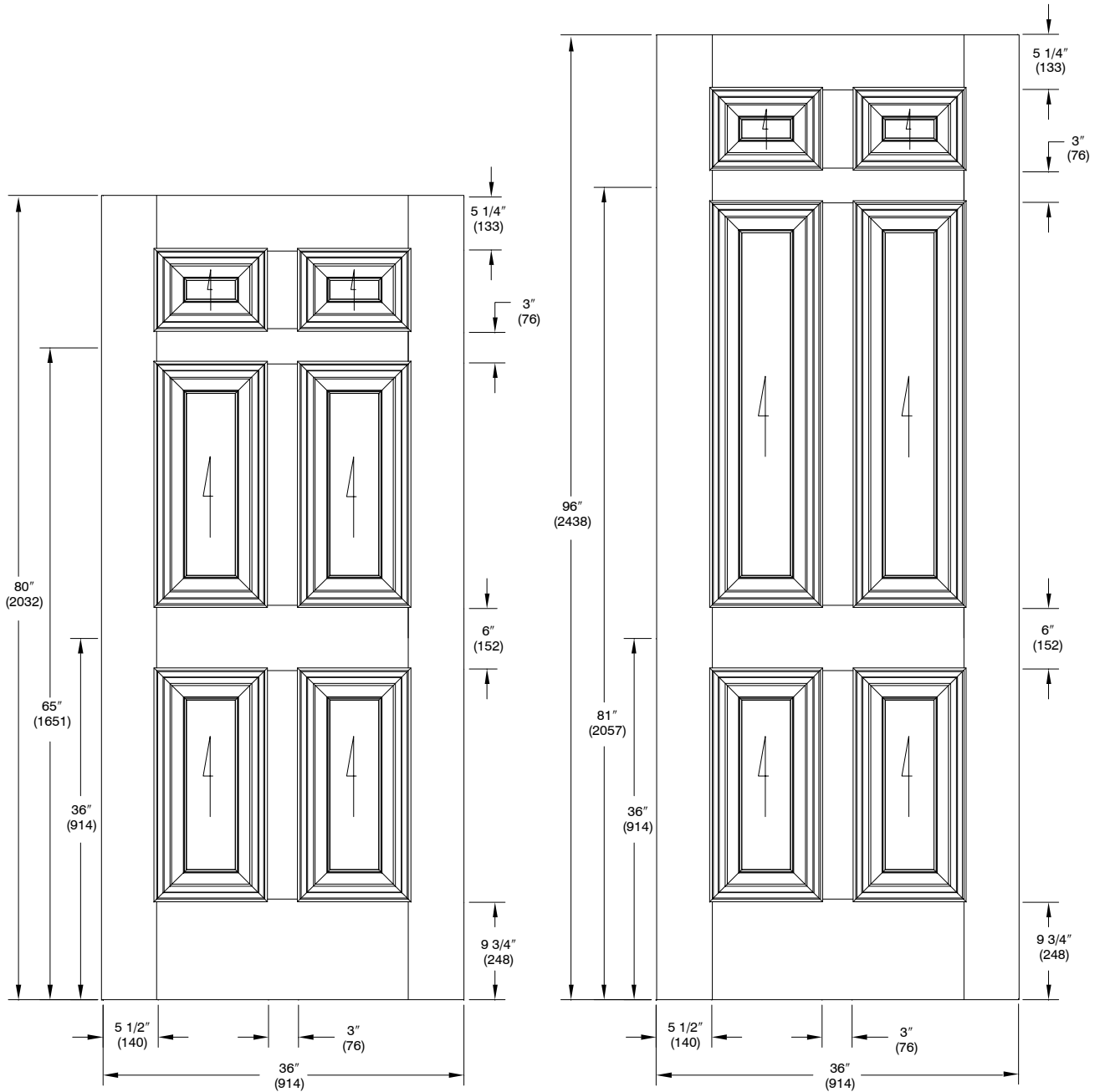

Profile M23/P400 shown

NOTE:
Panel sizes will be adjusted for operating clearance.

PANEL COLLECTIONS – TRADITIONAL

TRADITIONAL DOOR 1065 (PROFILE M23/P400 SHOWN)

SCALE: 3/4" = 1' 0"

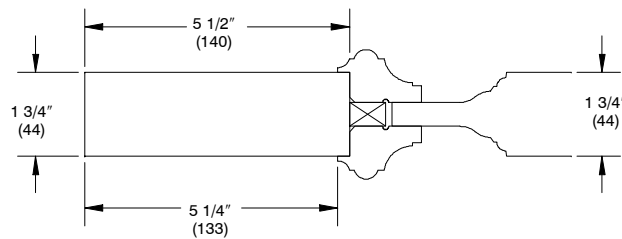
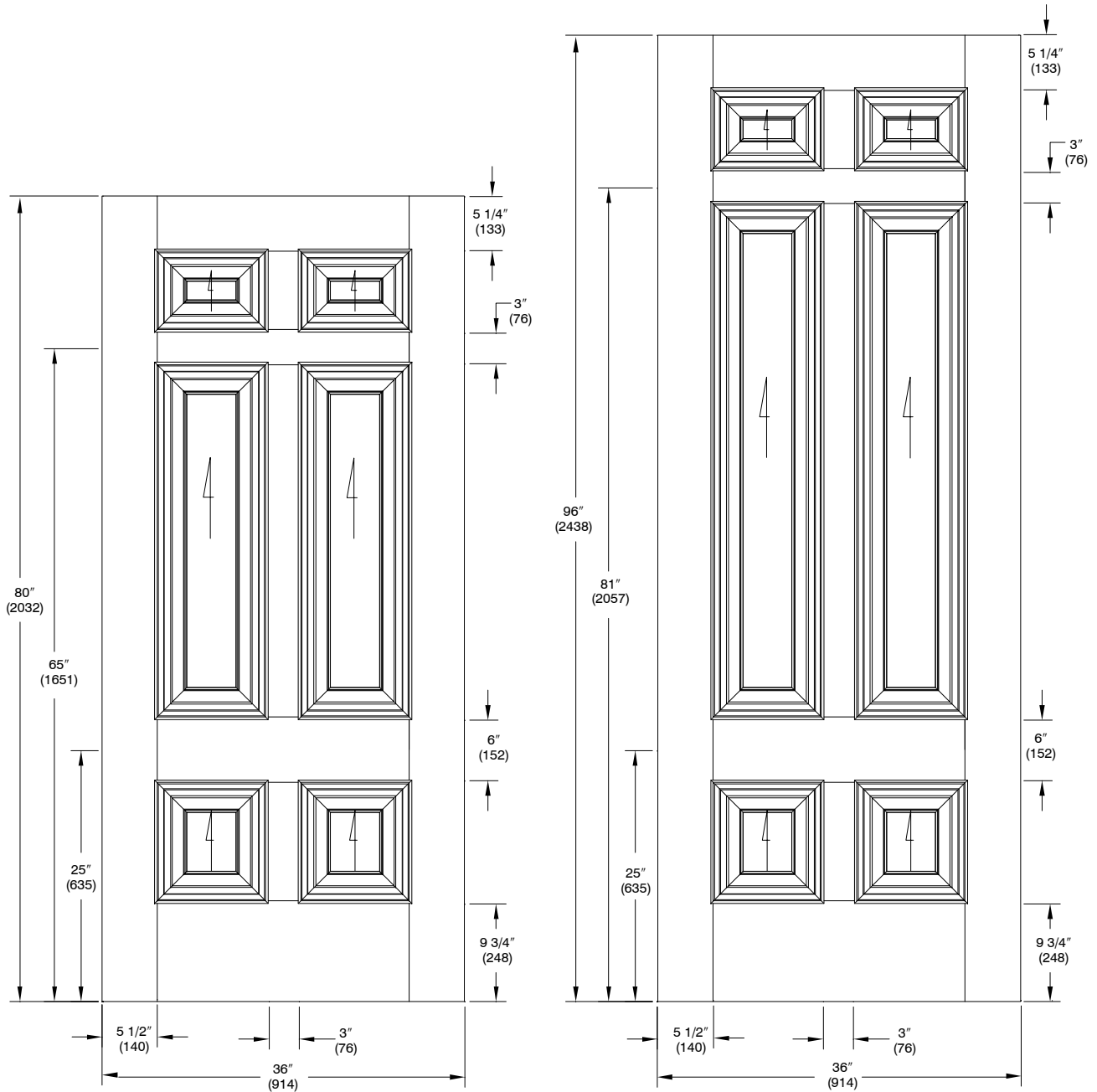

Profile M23/P400 shown

NOTE:
Panel sizes will be adjusted for operating clearance.

PANEL COLLECTIONS – TRADITIONAL

TRADITIONAL DOOR 1080 (PROFILE M23/P400 SHOWN)

SCALE: 3/4" = 1' 0"

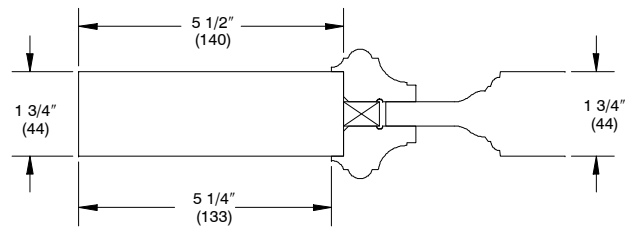
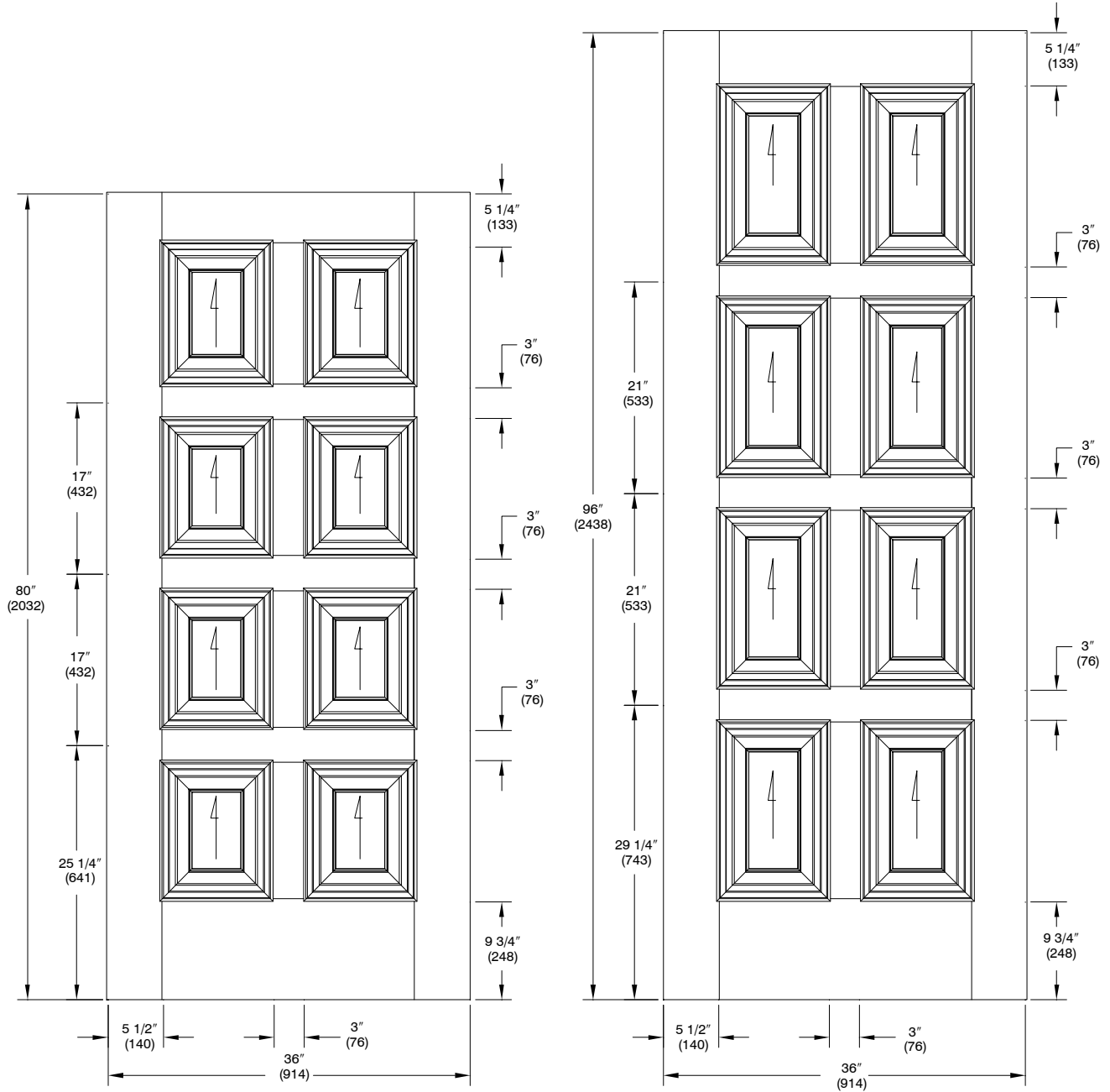

Profile M23/P400 shown

NOTE:

Panel sizes will be adjusted for operating clearance.

PANEL COLLECTIONS – TRADITIONAL

TRADITIONAL DOOR 1082 (PROFILE M23/P400 SHOWN)

SCALE: 3/4" = 1' 0"

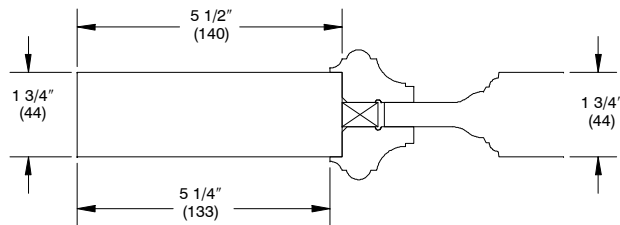
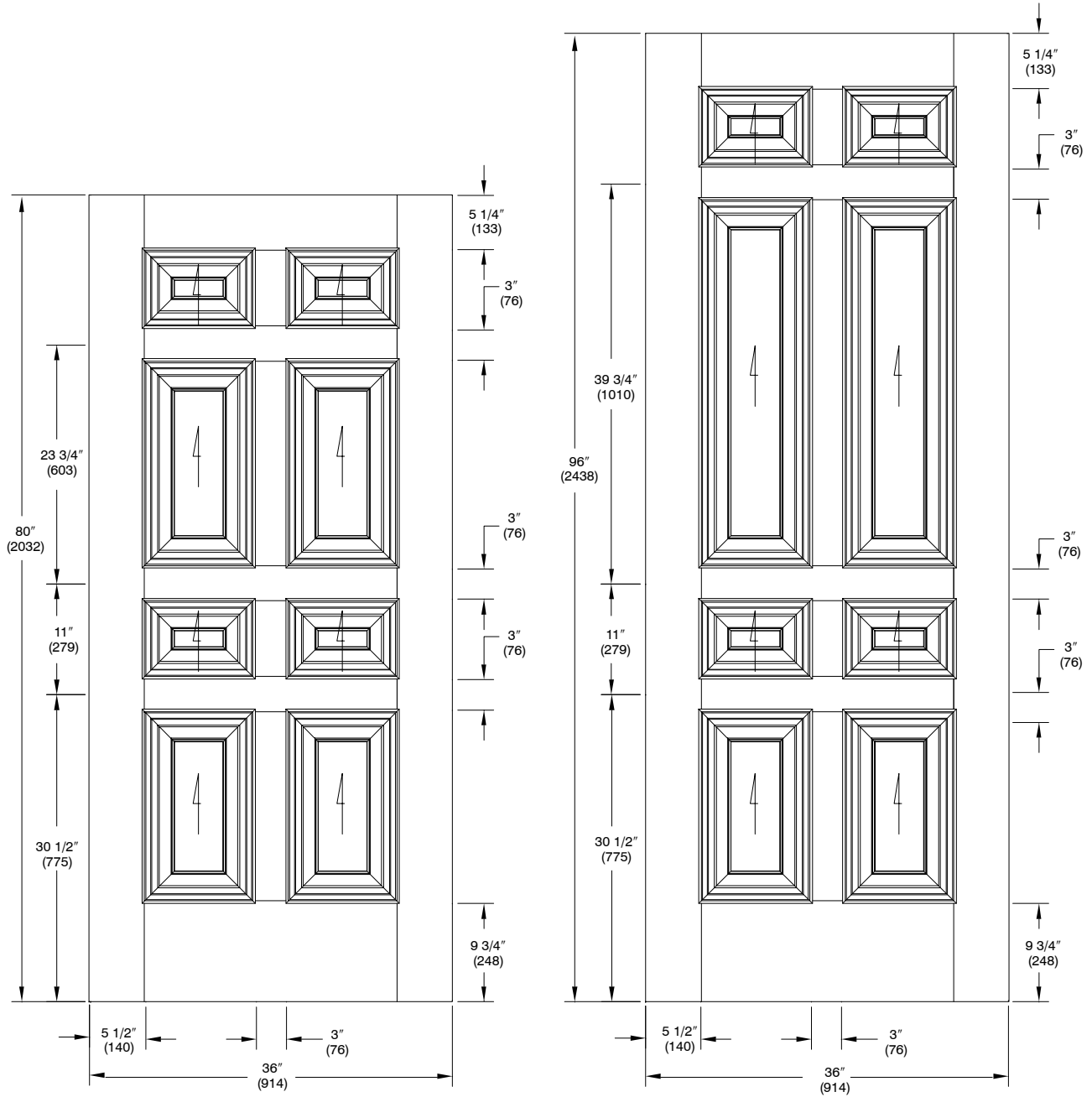

Profile M23/P400 shown

NOTE:
Panel sizes will be adjusted for operating clearance.

PANEL COLLECTIONS – TRADITIONAL

TRADITIONAL DOOR 1024AT SYSTEM (PROFILE M23/P400 SHOWN)

SCALE: 3/4" = 1' 0"

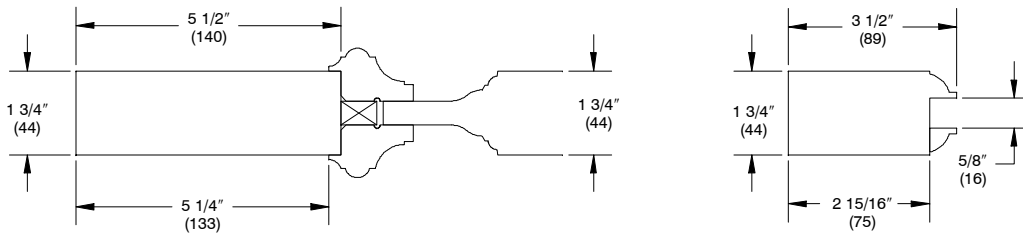
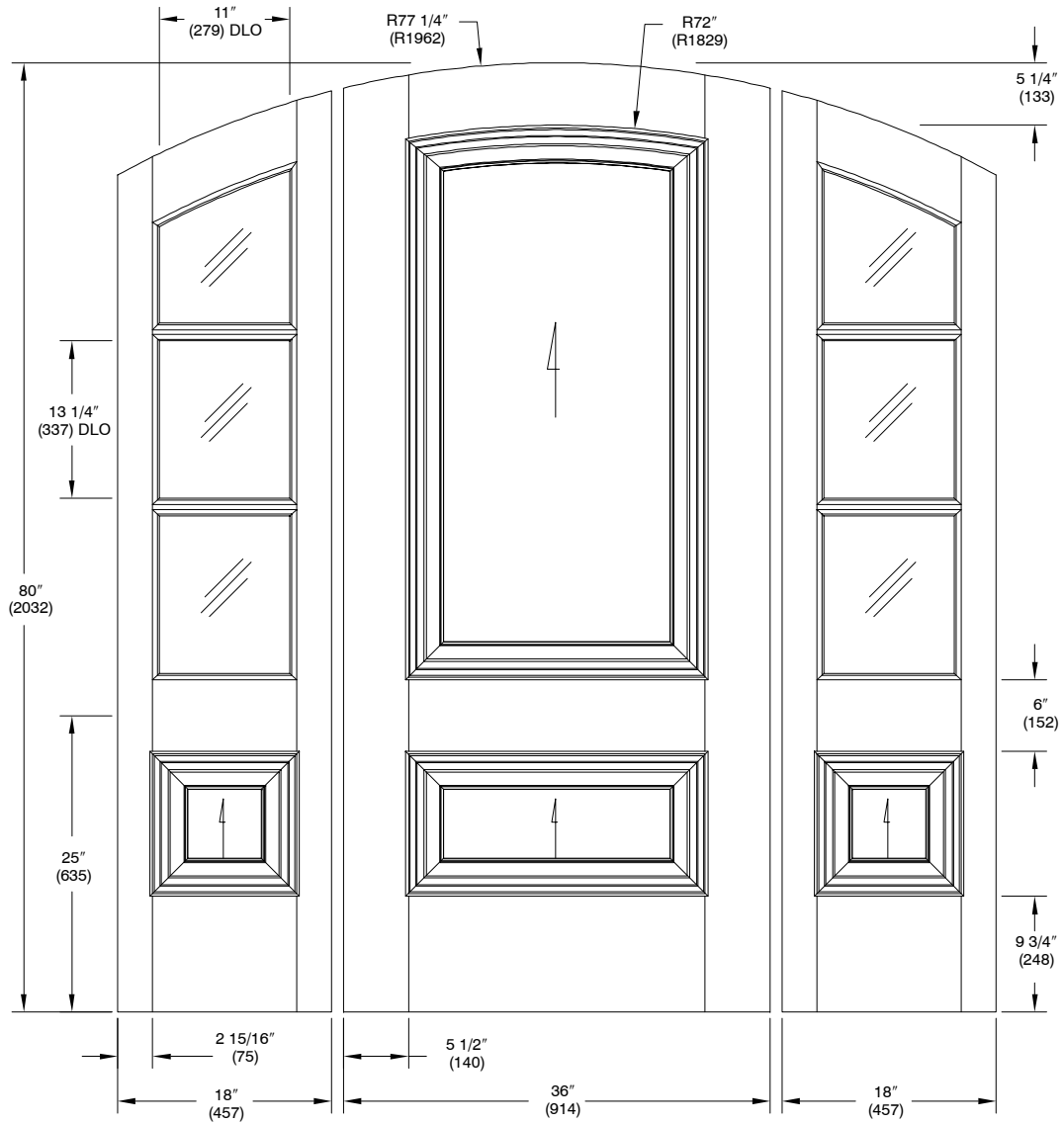

Profile M23/P400 shown

NOTE:

Panel sizes will be adjusted for operating clearance.